

GBJL15J-GBJL15M

Single-Phase 15.0A Glass Passivated Bridge Rectifier

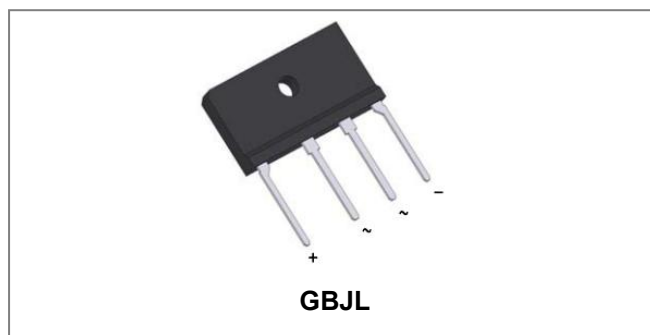

Features

- Glass passivated die construction
- Low forward voltage drop
- High current capability
- High surge current capability
- Plastic material-UL flammability 94V-0
- This is a Pb – Free Device
- All SMC parts are traceable to the wafer lot
- Additional testing can be offered upon request

Circuit Diagram

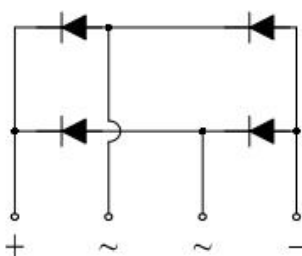

Mechanical Data

- Case: GBJL, Molded plastic
- Terminals: Plated leads solderable per MIL-STD-202, Method 208
- Polarity: as marked on body
- Mounting Position: Any
- Lead Free: For RoHS / Lead Free Version
- Mounting Torque: 10cm·kg (8.8inches·lbs) max;
- Recommend Torque: Mounting Torque: 5.7cm·kg (5inches·lbs);

Maximum Ratings @T_A=25°C unless otherwise specified

Type Number	Symbol	GBJL15J	GBJL15K	GBJL15M	Units
Peak Repetitive Reverse Voltage	V _{RRM}	600	800	1000	V
Working Peak Reverse Voltage	V _{RWM}				
DC Blocking Voltage	V _{DC}				
RMS Reverse Voltage	V _{RMS}	420	560	700	V
Average forward rectified output current @T _C = 110°C	I _(AV)	15.0			A
Peak Forward Surge Current, 8.3ms single half-sine-wave superimposed on rated load (JEDEC method)	I _{FSM}	240			A
Rating for fusing (t<8.3ms)	I ² t	240			A ² sec

Electrical Characteristics @ $T_A=25^{\circ}\text{C}$ unless otherwise specified

Type Number	Symbol	GBJL15J	GBJL15K	GBJL15M	Units
Forward Voltage (per element) @ $I_F = 7.5\text{A}$	V_F	1.0			V
Peak Reverse Current @ $T_A = 25^{\circ}\text{C}$ At Rated DC Blocking Voltage @ $T_A = 125^{\circ}\text{C}$	I_{RM}	5 150			μA

* Pulse width < 300 μs , duty cycle < 2%

Thermal-Mechanical Specifications:

Type Number	Symbol	GBJL15J	GBJL15K	GBJL15M	Units
Typical Thermal Resistance (per leg)	$R_{\theta JA}$ $R_{\theta JL}$	22 2.5			$^{\circ}\text{C/W}$
Operating and Storage Temperature Range	T_J, T_{STG}	-55 to +150			$^{\circ}\text{C}$

Notes: 1. Unit case mounted on Al plate heatsink;
2. Units mounted on PCB without heatsink;
3. Recommended mounting position is to bolt down on heatsink with silicone thermal compound for maximum heat transfer with #6 screw.

Ratings and Characteristics Curves

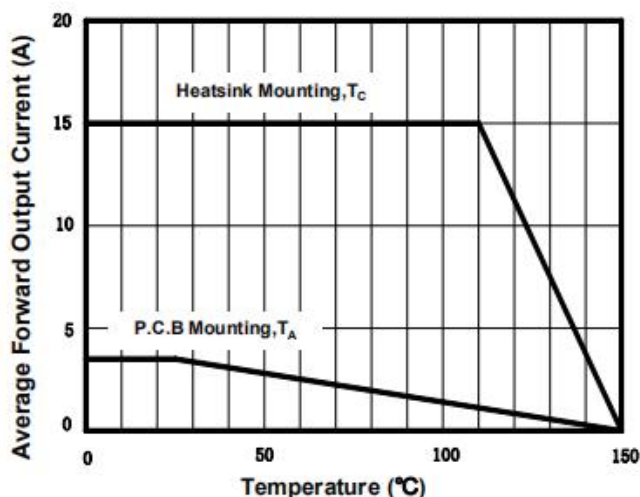

Figure 1. Derating Curve Output Rectified Current

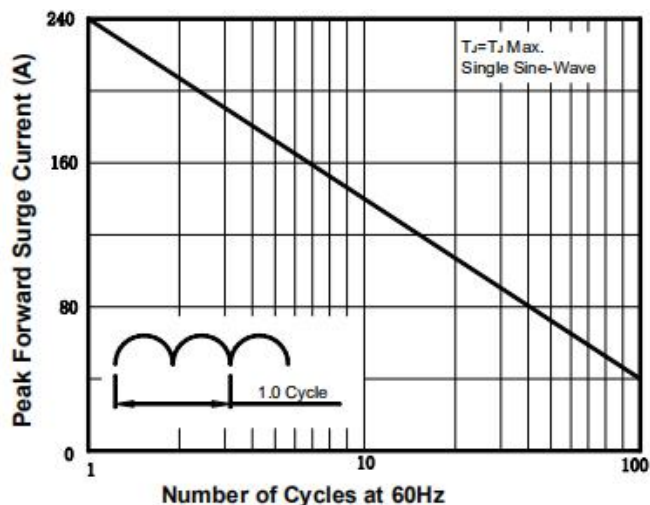

Figure 2. Maximum Non-Repetitive Peak Forward Surge Current per Diode

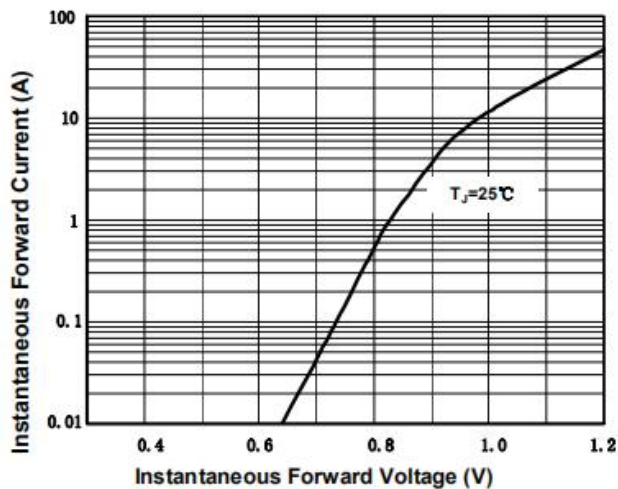

Figure 3. Typical Forward Characteristics Per Diode

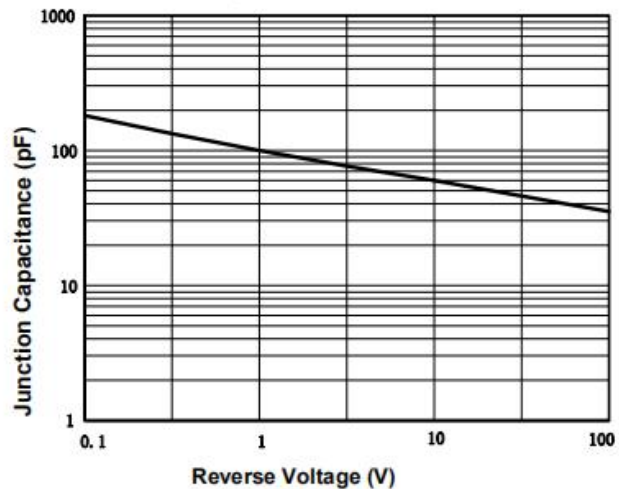

Figure 4. Typical Junction Capacitance Per Diode

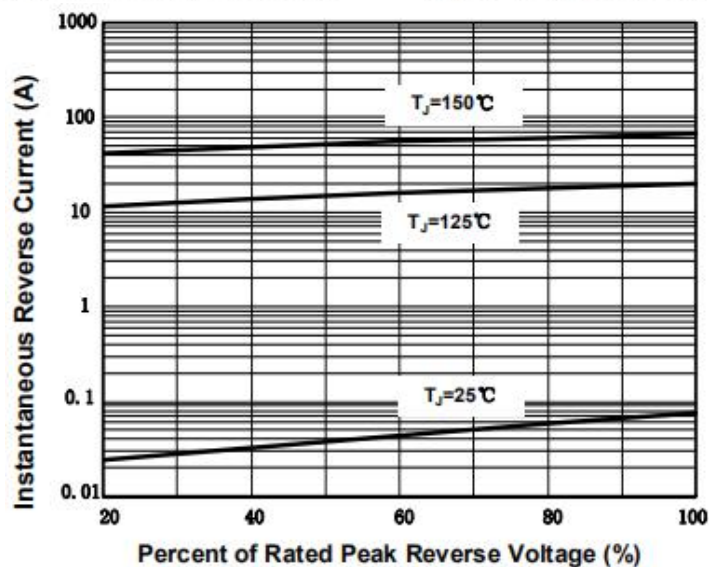
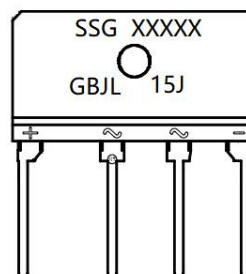

Figure 5. Typical Reverse Characteristics Per Diode

Ordering Information

Device	Package	Plating	Shipping
GBJL15J THRU GBJL15M	GBJL(Pb-Free)	Pure Sn	20pcs / tube

Marking Diagram



Where XXXXX is YYWWL

SSG = SSG
YY = Year
WW = Week
L = Lot Number
GBJL15J = Type Number

Cautions: Molding resin
Epoxy resin UL:94V-0

Mechanical Dimensions GBJL (Millimeters)

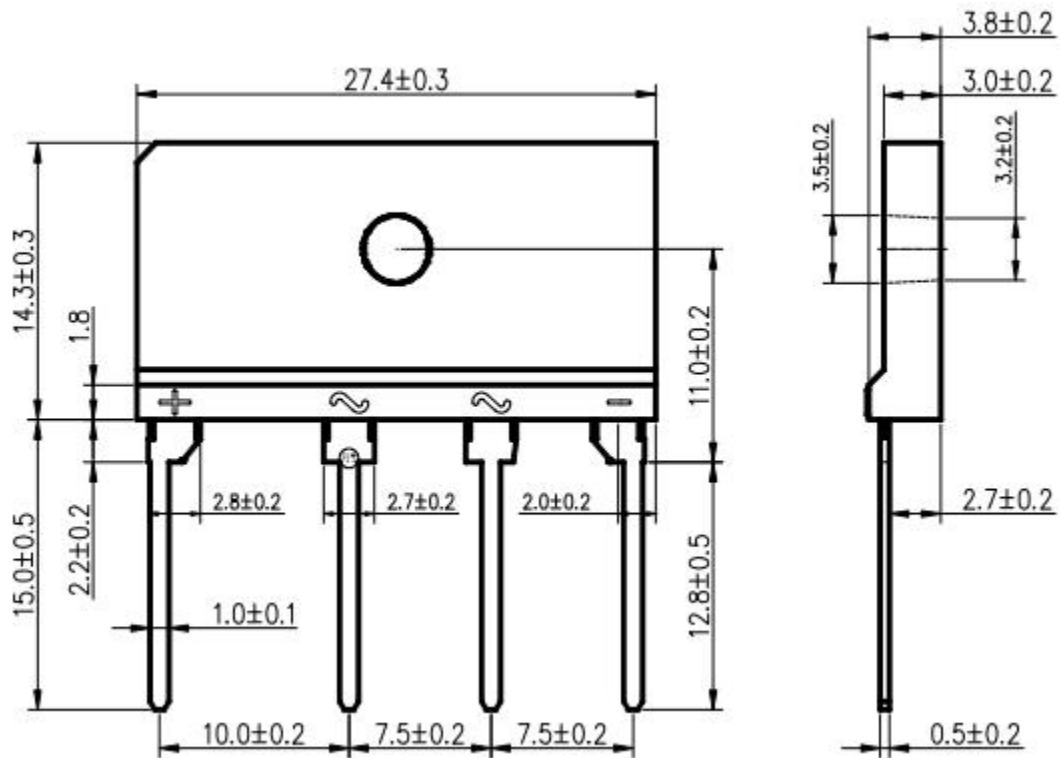



**GBJL15J
THRU
GBJL15M**

**Technical Data
Data Sheet N2242, Rev. -**



DISCLAIMER:

- 1- The information given herein, including the specifications and dimensions, is subject to change without prior notice to improve product characteristics. Before ordering, purchasers are advised to contact the SMC Diode Solutions sales department for the latest version of the datasheet(s).
- 2- In cases where extremely high reliability is required (such as use in nuclear power control, aerospace and aviation, traffic equipment, medical equipment, and safety equipment), safety should be ensured by using semiconductor devices that feature assured safety or by means of users' fail-safe precautions or other arrangement.
- 3- In no event shall SMC Diode Solutions be liable for any damages that may result from an accident or any other cause during operation of the user's units according to the datasheet(s). SMC Diode Solution assumes no responsibility for any intellectual property claims or any other problems that may result from applications of information, products or circuits described in the datasheets.
- 4- In no event shall SMC Diode Solutions be liable for any failure in a semiconductor device or any secondary damage resulting from use at a value exceeding the absolute maximum rating.
- 5- No license is granted by the datasheet(s) under any patents or other rights of any third party or SMC Diode Solutions.
- 6- The datasheet(s) may not be reproduced or duplicated, in any form, in whole or part, without the expressed written permission of SMC Diode Solutions.
- 7- The products (technologies) described in the datasheet(s) are not to be provided to any party whose purpose in their application will hinder maintenance of international peace and safety nor are they to be applied to that purpose by their direct purchasers or any third party. When exporting these products (technologies), the necessary procedures are to be taken in accordance with related laws and regulations.